

TECHNICAL SPECIFICATION FOR PVC SKIRTING BOARD

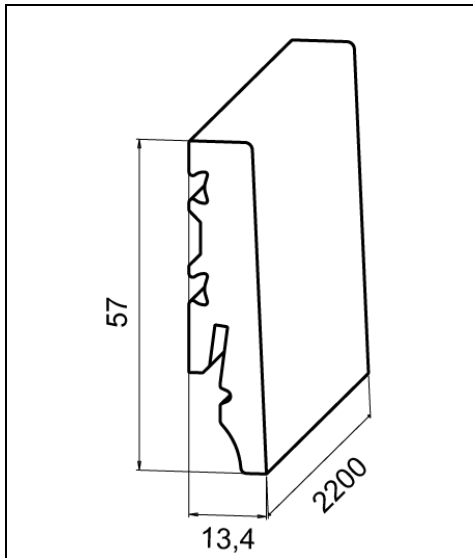

MATERIAL / DESIGN

Foamed polyvinyl chloride (PVC) - thermoplastic polymer, plastic with added dyes. Density: $580 \pm 20 \text{ kg/m}^3$.

Material resistant to chemicals and corrosion, waterproof.

Décors: finish film, thickness $0.057 \div 0.080 \text{ mm} \pm 20\%$, colour as ordered.

Skirting board cross-section

1. Finish film veneer
2. Foamed PVC core
3. Space for mounting clips
4. Cable cut-out

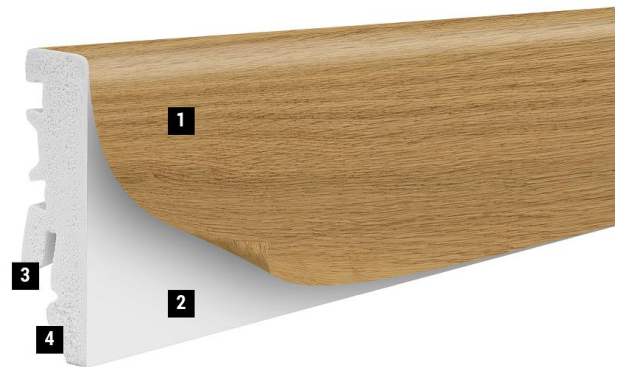

INSTALLATION

Skirting board installation:

Skirting board installation method*:

- with mounting glue
- with mounting clip
- with mounting clip and washer
- with anchors

Detailed skirting board installation instructions can be found at www.Barlinek.com and in the installation instructions for Barlinek floorboards.

*The width of the expansion gap covered by a strip mounted with mounting adhesive is 13.4mm.

The width of the expansion gap covered by a strip mounted with a mounting clip without a spacer is 13.4mm.





The width of the expansion gap covered by a strip mounted with a mounting clip with a spacer is 16.4mm.

INTENDED USE

Hybrid skirting boards made of foamed polyvinyl chloride (PVC), which guarantees their exceptional strength, resistance to chemicals and corrosion as well as water resistance. The skirting boards do not require additional protection or painting.

They can be installed in rooms exposed to moisture, e.g. bathrooms.

OP LAYER COLOURS

Index/EAN code/ catalogue number/colour	Photo for illustrative purposes showing the skirting board colour	Index/EAN code/ catalogue number/colour	Photo for illustrative purposes showing the skirting board colour
Index: LIS-PVC-DES-220-057-S60 Catalogue number: S6029511A EAN code: 5907461809959 Colour: Desert		Index: LIS-PVC-FLA-220-057-S60 Catalogue number: S6029521A EAN code: 5907461804077 Colour: Flax	
Index: LIS-PVC-GIN-220-057-S60 Catalogue number: S6029531A EAN code: 5907461804107 Colour: Ginger		Index: LIS-PVC-ANT-220-057-S60 Catalogue number: S6029051A EAN code: 5907461804138 Colour: Antic	
Index: LIS-PVC-CRE-220-057-S60 Catalogue number: S6029541A EAN code: 5907461804145 Colour: Cream			

DIMENSIONS OF AN INDIVIDUAL SKIRTING BOARD

Length:	2200 mm
Width:	13,4 mm
Height:	57 mm

PACKAGE / WEIGHT

Gross weight of one skirting board:	0,739 kg
Number of skirting boards in a package:	12
Weight of one package:	8,86 kg
Number of packages on a pallet:	48
Pallet weight (skirting boards + pallet):	445,40 kg
Dimensions of a pallet (length/width/height)	2200x800x820